

Mandatory Disclosure

	Mandatory Disclosure	Updated on 17th January 2012
1.	AICTE File No.	765-65-202(E)/ET/95
	Date & Period of last approval	01 st September 2011
2.	Name of the Institution	Beant College of Engg. & Technology
	Address of the Institution	Post Box No 13 Gurdaspur-Pathankot Road Gurdaspur Punjab-143521 Gurdaspur -143521
	City & Pin Code	
	State / UT	Punjab
	Longitude & Latitude	75.26E & 32.03N
	Phone number with STD code	01874-221463
	FAX number with STD code	01874-221464
	Office hours at the Institution	8
	Academic hours at the Institution	8
	Email	pbcetgsp@gmail.com
	Website	www.bcetgsp.ac.in
	Nearest Railway Station (dist in Km)	5
	Nearest Airport (dist in Km)	95
3.	Type of Institution	Government
	Category (1) of the Institution	Non Minority
	Category (2) of the Institution	Co-Educational
4.	Name of the organization running the Institution	State Government
	Type of the organization	Society
	Address of the organization	Beant College of Engg. & Technology
	Registered with	Punjab Government
	Registration date	6th December 1993
	Website of the organization:	www.bcetgsp.ac.in
5.	Name of the affiliating University:	Punjab Technical University
	Address:	Kapurthala Road Jalandhar, Punjab
	Website:	www.ptu.ac.in
	Latest affiliation period	3 Years
6.	Name of Principal:	Dr Dial Chand
	Exact Designation:	Principal
	Phone number with STD code	01874-221464
	FAX number with STD code	01874-221464
	Email	pbcetgsp@gmail.com
	Highest Degree	PhD
	Field of specialization	Elastic & Magneto Thermo-Elastic Media



7. Governing Board Members:

- Technical Education Minister, Punjab
- Secretary to the Government of Punjab, Department of Finance
- Secretary to the Government of Punjab, Department of Technical Education
- Secretary to the Government of Punjab, Department of Science and Technology, & Environment
- Director, Technical Education, Punjab
- One MLA. holding a Technical Degree
- Not more than two members from amongst Govt. of India/All India Institutions
- Any other two members whose experience is considered relevant to the cause of technical education of management of the colleges. These could also be chosen out of Senior State Govt. Officers
- The Vice-Chancellor of the affiliating University or his nominee
- Industrial/Technologist in the region to be nominated by the State Government
- Nominee of the University Grants Commission
- One representative of the faculty from amongst Professors for one year to be nominated by the Chairperson Board of Governors
- Chairman/Chairperson, Punjab State Board of Technical Education & Industrial Training, Punjab
- Principal of the Beant College of Engineering & Technology, Gurdaspur

8. Frequency of meeting & date of last Meeting
Academic Advisory Body

Twice a Year & 3rd March 2008

Board of Studies (B.O.S.) constituted by PTU, Jalandhar to formulate/revise the B.Tech. and M. Tech Courses Curriculum.

Frequency of meeting & date of last Meeting

Twice a year. However, the meetings for the academic council are held quarterly or as demanded as per need of the hour.

9. Organizational Charts

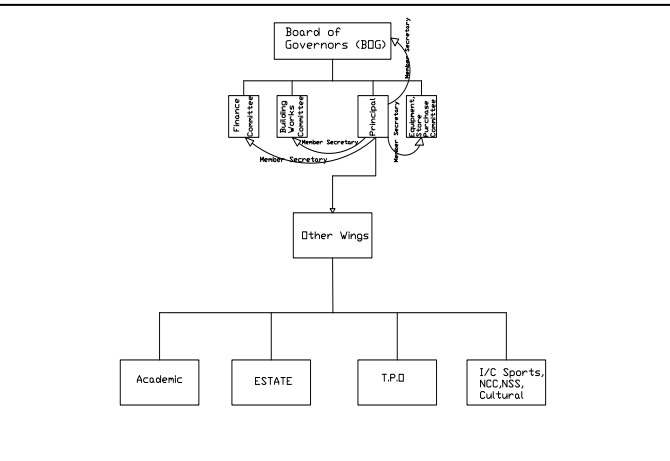
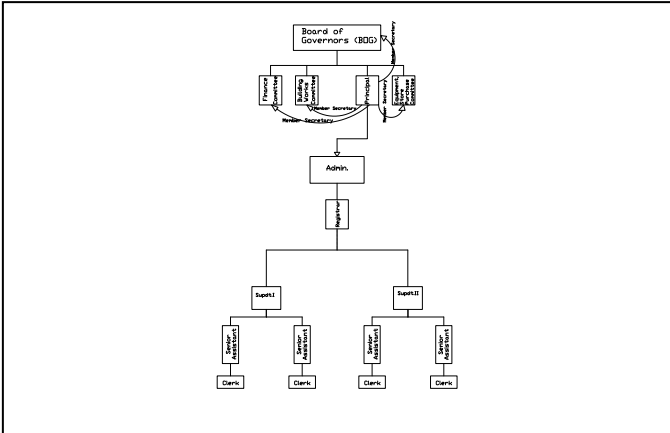
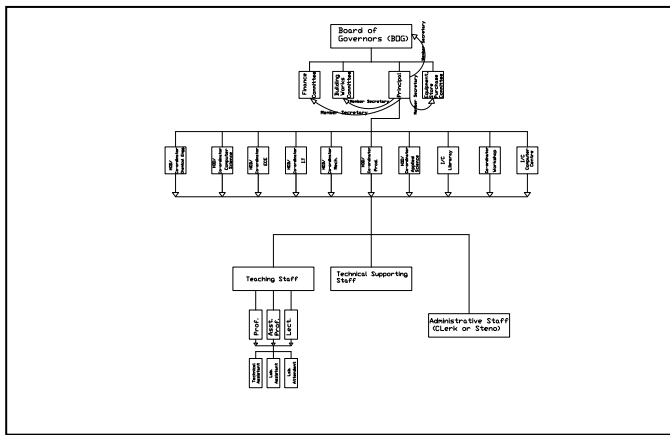
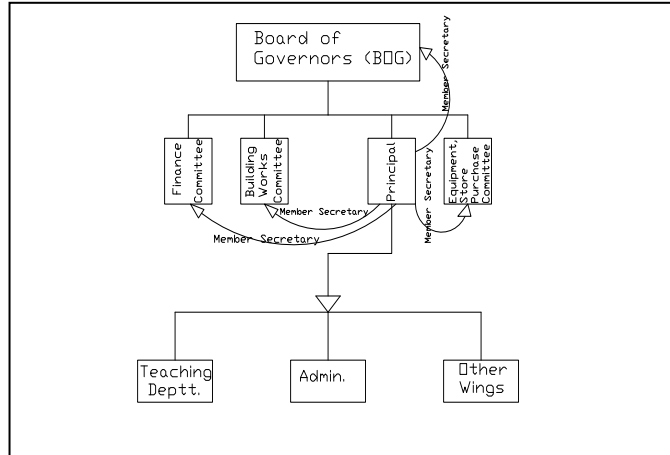

10. Student feedback mechanism on Institutional Governance/faculty Performance

BEANT COLLEGE OF ENGINEERING & TECHNOLOGY GURDASPUR

STUDENT'S FEEDBACK FORM

Session _____ Class _____ Subject _____
 Name of Teacher _____

Note: (1) Please do not disclose your identity anywhere on this form
 (2) Please tick mark in the appropriate column to give your response.

(I) Teaching Attributes:-

Sr. No.	Attribute	Excellent	V.Good	Good	Fair	Poor
1	Knowledge of the Subject					
2	Way of Teaching Method of Expression					
3	Oral Communication in Class					
4	Interaction with students in Tutorial class					
5	Experimental skills in Lab Class					
6	Use of Teaching Aids					
7	Punctuality in class					
8	Regularity in Evaluation and Return of Home Assignments					
9	Regularity in Evaluation and Return of Class tests					
10	Assessment of students					

(II) General Attributes:-

Sr. No.	Attribute	Excellent	V.Good	Good	Fair	Poor
1	Control of class					
2	Ability of Motivating students					
3	Integrity					
4	Ability to take Initiative					
5	Sense of Humor					

(III) Other Considerations:-

(i) Would you like to study another subject from the same teacher? YES/NO
 (ii) Should the same teacher continue to teach this subject to forthcoming batches? YES/NO
 (iii) What is your overall rating of the teacher on an overall scale of 10?

11. Grievance redressal mechanism for faculty, staff and students

The feedback from the students is gathered by the HOD/Co-ordinators of the concerned department on his personal basis. Thereafter, the HOD/Coordinators prepares cumulative information about the faculty/staff of the department in concern and the said faculty / staff member is informed about the feedback to improve upon his teaching methodology and interaction with the students. The requirements/ problems of the faculty/staff members are looked into and the solutions are worked out by the Principal by convening meeting with all the HOD/Co-ordinators.

12(a) **UG/PG Level**

Name of the Department (A)	Mechanical Engineering		
Course	Mechanical Engineering		
Level UG / PG	UG		
1st Year of approval by the Council	F.700-20/PB(3)/RC/94 dated 17th June 1994		
Year wise Sanctioned Intake	90	90	90
Year wise Actual Admissions	90 + Fee Waiver	90+FeeWaiver	90+Fee Waiver
Cut off marks – General quota	Rank 23617	Rank 23237	Rank 19828
% Students passed with Distinction	04	02	01
% Students passed with First Class	41	71	54
Students Placed	37	26	24
Average Pay package, Rs./Year	200000	280000	240000
Students opted for Higher Studies	-	2	-
Accreditation Status of the course	Accredited		
Doctoral Courses	No		
Foreign Collaborations, if any	No		
Professional Society Memberships	Society of Automotive Engg		
Professional activities	Yes		
Consultancy activities	Yes		
Grants fetched	25,00,000		
Departmental Achievements	Highest PhD faculty		
Distinguished Alumni	Siddhartha Sood (L& T InfoTech) & Bhupinder Saini (Infosys)		

Course

Thermal Engineering

Level UG / PG	PG		
1st Year of approval by the Council	F.765-65/202 (E)/ET/95 dated 13-07-2007		
Year wise Sanctioned Intake	18	18	18
Year wise Actual Admissions	16	02	05
Cut off marks – General quota	NA	NA	NA
% Students passed with Distinction	NA	NA	NA
% Students passed with First Class	NA	NA	NA
Students Placed	NA	NA	02
Average Pay package, Rs./Year	NA	NA	240000
Students opted for Higher Studies	NA	NA	-
Accreditation Status of the course	Not Accredited		
Doctoral Courses	No		
Foreign Collaborations, if any	No		
Professional Society Memberships	Society of Automotive Engg		
Professional activities	Yes		
Consultancy activities	Yes		
Grants fetched	25,00,000		
Departmental Achievements	Highest PhD faculty		
Distinguished Alumni	Aman Soi		

Name of the Department (B)	Chemical Engineering & Bio Technology		
Course	Chemical Engineering		
Level UG / PG	UG		
1st Year of approval by the Council	F.765-65/202 (E)/ET/97/341 dt. 15-04-1997		
Year wise Sanctioned Intake	30	30	30
Year wise Actual Admissions	30 + Fee Waiver	26	39
Cut off marks – General quota	Rank 24252	Rank 22082	Rank 20500
% Students passed with Distinction	04	02	02
% Students passed with First Class	14	74	53
Students Placed	04	04	01
Average Pay package, Rs./Year	150000	250000	240000
Students opted for Higher Studies	04	03	05
Accreditation Status of the course	Not Accredited		
Doctoral Courses	No		
Foreign Collaborations, if any	No		
Professional Society Memberships	No		
Professional activities	Yes		
Consultancy activities	Yes		
Grants fetched	3,00,000		
Departmental Achievements	Faculty achieved Post Graduate Degree		
Distinguished Alumni	Bharti Chopra (RIL) and Ashish Monga(HLL)		

Course	Bio Technology		
Level UG / PG	UG		
1st Year of approval by the Council	F.765-65/202 (E)/ET/95 dated 27-07-2006		
Year wise Sanctioned Intake	60	60	60
Year wise Actual Admissions	60 + Fee Waiver	60+Fee Waiver	60+Fee Waiver
Cut off marks – General quota	Rank 27590	Rank 22088	Rank 21433
% Students passed with Distinction	07	NA	NA
% Students passed with First Class	42	NA	NA
Students Placed	00	NA	NA
Average Pay package, Rs./Year	NA	NA	NA
Students opted for Higher Studies	02	NA	NA
Accreditation Status of the course	Not Accredited		
Doctoral Courses	No		
Foreign Collaborations, if any	No		
Professional Society Memberships	No		
Professional activities	Yes		
Consultancy activities	Yes		
Grants fetched	Nil		
Departmental Achievements	Progressing		
Distinguished Alumni	-		

Name of the Department (C)

**Computer Science & Engineering and
Information Technology**

Course

Computer Science & Engineering

Level UG / PG

UG

1st Year of approval by the Council

F.700-20/PB(3)/RC/94 dated 17th June 1994

Year wise Sanctioned Intake

120 120 90

Year wise Actual Admissions

120 + Fee Waiver 120+Fee Waiver 90+Fee Waiver

Cut off marks – General quota

Rank 15835 Rank 18589 Rank 18269

% Students passed with Distinction

16 0 2 02

% Students passed with First Class

49 8 3 85

Students Placed

10 4 7 39

Average Pay package, Rs./Year

240000 270000 260000

Students opted for Higher Studies

04 03 03

Accreditation Status of the course

Accredited

Doctoral Courses

No

Foreign Collaborations, if any

No

Professional Society Memberships

No

Professional activities

Yes

Consultancy activities

Yes

Grants fetched

Rs.90,000

Departmental Achievements

Faculty achieved Post Graduate Degree

Distinguished Alumni

Ankush (Satyam) & Manav (L&T InfoTech)

Course

Information Technology

Level UG / PG

UG

1st Year of approval by the Council

F.765-65/202 (E)/ET/95 dated 27- 07- 2006

Year wise Sanctioned Intake

6 0 60 60

Year wise Actual Admissions

6 0 + F e e Waiver 60+Fee Waiver 60+Fee Waiver

Cut off marks – General quota

Rank 23785 Rank 21067 Rank 20126

% Students passed with Distinction

22 0 2 01

% Students passed with First Class

67 9 0 83

Students Placed

07 20 15

Average Pay package, Rs./Year

220000 2 70000 260000

Students opted for Higher Studies

03 0 3 01

Accreditation Status of the course

Not Accredited

Doctoral Courses

No

Foreign Collaborations, if any

No

Professional Society Memberships

No

Professional activities

Yes

Consultancy activities

Yes

Grants fetched

No

Departmental Achievements

-

Distinguished Alumni

Manav Kundra(L&T InfoTech)&Parul (Satyam)

Name of the Department (D)	Electronics & Communication Engg		
Course	Electronics & Communication Engg		
Level UG / PG	UG		
1st Year of approval by the Council	F.767-1/5 (E)/ET/97 dated 08-08-1997		
Year wise Sanctioned Intake	120	120	60
Year wise Actual Admissions	120 + Fee Waiver	120+Fee Waiver	60+Fee Waiver
Cut off marks – General quota	Rank 14535	Rank 23242	Rank 18978
% Students passed with Distinction	20	02	02
% Students passed with First Class	83	91	90
Students Placed	07	48	48
Average Pay package, Rs./Year	220000	290000	280000
Students opted for Higher Studies	03	03	01
Accreditation Status of the course	Accredited		
Doctoral Courses	No		
Foreign Collaborations, if any	No		
Professional Society Memberships	No		
Professional activities	Yes		
Consultancy activities	Yes		
Grants fetched	5,00,000		
Departmental Achievements	Faculty achieved Post Graduate Degree		
Distinguished Alumni	Sukhpreet Kaur (Motorola) & Randeep (Satyam)		

12(b) **Polytechnic Departments**

Name of the Department (A)	Mechanical Engineering		
Course	Mechanical Engineering		
Level	Diploma		
1st Year of approval by the Council			
Year wise Sanctioned Intake	60	60	60
Year wise Actual Admissions	60 + Fee Waiver	60+FeeWaiver	60+Fee Waiver
Cut off marks – General quota	8812	-	-
% Students passed with Distinction	yet to pass out first batch		
% Students passed with First Class			
Students Placed			
Average Pay package, Rs./Year			
Students opted for Higher Studies			
Accreditation Status of the course	Not Accredited		
Doctoral Courses	No		
Foreign Collaborations, if any	No		
Professional Society Memberships	NO		
Professional activities	NO		
Consultancy activities	NO		
Grants fetched	NO		
Departmental Achievements			
Distinguished Alumni			

Name of the Department (B)
 Course
 Level
 1st Year of approval by the Council
 Year wise Sanctioned Intake
 Year wise Actual Admissions
 Cut off marks – General quota
 % Students passed with Distinction
 % Students passed with First Class
 Students Placed
 Average Pay package, Rs./Year
 Students opted for Higher Studies
 Accreditation Status of the course
 Doctoral Courses
 Foreign Collaborations, if any
 Professional Society Memberships
 Professional activities
 Consultancy activities
 Grants fetched
 Departmental Achievements
 Distinguished Alumni

Computer Engineering
Computer Engg.
 Diploma

60	60	60
60 + Fee Waiver	60+FeeWaiver	60+Fee Waiver
13880	-	-
yet to pass out first batch		
Not Accredited		
No		
No		
NO		
NO		
NO		
NO		

Name of the Department (C)
 Course
 Level UG / PG
 1st Year of approval by the Council
 Year wise Sanctioned Intake
 Year wise Actual Admissions
 Cut off marks – General quota
 % Students passed with Distinction
 % Students passed with First Class
 Students Placed
 Average Pay package, Rs./Year
 Students opted for Higher Studies
 Accreditation Status of the course
 Doctoral Courses
 Foreign Collaborations, if any
 Professional Society Memberships
 Professional activities
 Consultancy activities
 Grants fetched
 Departmental Achievements
 Distinguished Alumni

Electronics & Communication Engg.
ECE
 Diploma

60	60	60
60 + Fee Waiver	60+FeeWaiver	60+Fee Waiver
15836	-	-
yet to pass out first batch		
Not Accredited		
No		
No		
NO		
NO		
NO		
NO		

13(a) **UG/ PG Level Teaching Faculty**

Name of Teaching Staff

Designation

Department

Date of Joining the Institution

Qualifications with Class/Grade

Total Experience in Years

No Papers Published in Journals

Papers Presented in Conferences

PhD Guide? Give field & University

PhDs / Projects Guided

Books Published / IPRs/ Patents

Professional Memberships

Consultancy Activities

Awards

Grants fetched

Interaction with Professional Institutions:

Dr. Baljinder Kaur Gill

Assistant Professor

Chemical Engineering

05-08-1996

B.E (First Division)

M.E (First Division) Ph. D

Teaching =11

National= 01 International=03

National= 01 International=02

Nil

Nil

Nil

Nil

Nil

Nil

Nil

Panjab University Chandigarh



Name of Teaching Staff

Designation

Department

Date of Joining the Institution

Qualifications

Total Experience in Years

Papers Published

Papers Presented in Conferences

PhD Guide. Give field & University

PhDs / Projects Projects at Masters Level

Books Published / IPRs/ Patents

Professional Memberships

Consultancy Activities

Awards

Grants fetched

Interaction with Professional Institutions

BALJEEV KUMAR

Assistant Professor

Chemical Engineering

21-09-1998

B.Tech (First Division)

M.Tech (First Division)

Teaching =11 Industry = 09

National= Nil International=Nil

National= 01 International=Nil

Nil

Nil

Nil

ISTE Membership

Nil

Nil

Nil

CIPET, Amritsar



Name of Teaching Staff

Designation

Department

Date of Joining the Institution

Qualifications with Class/Grade

Total Experience in Years Teaching

No Papers Published in Journals

(Attach detailList)

Papers Presented in Conferences

(Attach detail List)

P.K.YADAV

Assistant Professor

Chemical Engineering

04.09.98

B.Tech, M.Tech

12

National=NIL International=NIL

National= 01 International=NIL



PhD Guide ? Give field & University	NIL
PhDs / Projects Guided PhDs	NIL
Books Published / IPRs/ Patents	NIL
Professional Memberships	Life Member of ISTE
Consultancy Activities	NIL
Awards	NIL
Grants fetched	NIL
Interaction with Professional Institutions	NIL

Name of Teaching Staff

Designation	SEEMA Assistant Professor
Department	Chemical Engineering
Date of Joining the Institution	17-07-2000
Qualifications with Class/Grade	B.Tech Chemical Engg (First division), MSc Biotechnology
Total Experience in Years Teaching	16yrs
No Papers Published in Journals (Attach detail List)	Nil
Papers Presented in Conferences (Attach detail List)	03
PhD Guide ? Give field & University	Nil
Books Published / IPRs/ Patents	Nil
Professional Memberships	Nil
Consultancy Activities	Nil
Awards	Nil
Grants fetched	Nil
Interaction with Professional Institutions	Nil



Name of Teaching Staff

Designation	VIPAN KUMAR Assistant Professor
Department	Chemical Engineering
Date of Joining the Institution	17-07-2000
Qualifications with Class/Grade	B.Tech (First Division) M.Tech (First Division)
Total Experience in Years Teaching	11
No Papers Published in Journals	National= Nil International=02
Papers Presented in Conferences	National= 05 International=03
PhD Guide? Give field & University	Nil
PhDs / Projects Guided	Nil
Books Published / IPRs/ Patents	One
Professional Memberships	Bioinformatics Institute of India International Association of Engineer
Consultancy Activities	Nil
Awards	Nil
Grants fetched	Nil
Interaction with Professional Institutions:	JNU Delhi & IIT Delhi



Name of Teaching Staff

Designation
 Department
 Date of Joining the Institution
 Qualifications with Class/Grade
 Total Experience in Years Teaching
 No Papers Published in Journals
 Papers Presented in Conferences
 PhD Guide? Give field & University
 PhDs / Projects Guided
 Books Published / IPRs/ Patents
 Professional Memberships
 Consultancy Activities
 Awards
 Grants fetched
 Interaction with Professional Institutions:

MANIDER PAL

Assistant Professor
 Chemical Engineering
 16-10-2001
 B.Tech (First Division)
 9
 National= 0 International=0
 National= 0 International=0
 Nil
 Nil
 Nil
 Nil
 Nil
 Nil
 Nil
 Nil

**Name of Teaching Staff**

Designation
 Department
 Date of Joining the Institution
 Qualifications with Class/Grade
 Total Experience in Years Teaching
 No Papers Published in Journals
 Papers Presented in Conferences
 PhD Guide ? Give field & University
 PhDs / Projects Guided
 Books Published / IPRs/ Patents
 Professional Memberships
 Consultancy Activities
 Awards
 Grants fetched
 Interaction with Professional Institutions

RAJESH KUMAR SHARMA

Assistant Professor
 Chemical Engineering
 11-11-2008
 B.Tech, M.E (first division)
 09
 National= **01** International=**00**
 National= **01** International=**00**
 Nil
 Nil
 Nil
 Life Member of ISTE
 Nil
 Nil
 Nil
 Nil

**Name of Teaching Staff**

Designation
 Department
 Date of Joining the Institution
 Qualifications with Class/Grade
 Total Experience in Years Teaching
 No Papers Published in Journals
 (Attach detail List)
 Papers Presented in Conferences
 (Attach detail List)
 PhD Guide ? Give field & University
 PhDs / Projects Guided

AKSHAYE KOHLI

Assistant Professor
 Chemical Engineering
 06-01-2010
 B.Tech
 2
 National= **00** International=**00**
 National= **00** International=**00**
 Nil
 Nil



Books Published / IPRs/ Patents	Nil
Professional Memberships	Nil
Consultancy Activities	Nil
Awards	Nil
Grants fetched	Nil
Interaction with Professional Institutions	Nil

Name of Teaching Staff

Designation
 Department
 Date of Joining the Institution
 Qualifications with Class/Grade
 Total Experience in Years Teaching
 No Papers Published in Journals
 Papers Presented in Conferences
 PhD Guide ? Give field & University
 Books Published / IPRs/ Patents
 Professional Memberships
 Consultancy Activities
 Awards
 Grants fetched
 Interaction with Professional Institutions

Vijay Sodhi

Assistant Professor
 Chemical Engineering
 02-08-2010
 B.Tech (First division), M. Tech.
 6 months
 01
 02
 Nil
 Nil
 ICEA
 Nil
 Nil
 Nil
 Nil



Name of Teaching Staff

Designation
 Department
 Date of Joining the Institution
 Qualifications with Class/Grade
 Total Experience in Years Teaching
 No Papers Published in Journals
 Papers Presented in Conferences
 PhD Guide ? Give field & University
 Books Published / IPRs/ Patents
 Professional Memberships
 Consultancy Activities
 Awards
 Grants fetched
 Interaction with Professional Institutions

Mandeep Kaur

Assistant Professor
 Chemical Engineering
 17-01-2011
 B.Tech (First division)
 1 month
 Nil
 Nil
 Nil
 Nil
 Nil
 Nil
 Nil
 Nil



Name of Teaching Staff

Designation
 Department
 Date of Joining the Institution
 Qualifications with Class/Grade
 Total Experience in Years Teaching
 No Papers Published in Journals

Neha Mahajan

Assistant Professor
 Chemical Engineering
 17-01-2011
 B.Tech (First division)
 1 month
 Nil



Papers Presented in Conferences	Nil
PhD Guide ? Give field & University	Nil
Books Published / IPRs/ Patents	Nil
Professional Memberships	Nil
Consultancy Activities	Nil
Awards	Nil
Grants fetched	Nil
Interaction with Professional Institutions	Nil

Name of Teaching Staff

Designation	HARSHARAN KAUR
Department	Assistant Professor
Date of Joining the Institution	Biotechnology
Qualifications with Class/Grade	27-01-2009
Total Experience in Years Teaching	B. Tech (First division)
No Papers Published in Journals	2
Papers Presented in Conferences	Nil
PhD Guide ? Give field & University	Nil
Books Published / IPRs/ Patents	Nil
Professional Memberships	Nil
Consultancy Activities	Nil
Awards	Nil
Grants fetched	Nil
Interaction with Professional Institutions	Nil



Name of Teaching Staff

Designation	Manpreet Singh
Department	Assistant Professor
Date of Joining the Institution	Biotechnology
Qualifications with Class/Grade	17-01-2011
Total Experience in Years Teaching	B. Tech
No Papers Published in Journals (Attach detail List)	0.5
Papers Presented in Conferences (Attach detail List)	National= 00 International=00
PhD Guide Give field & University	National= 00 International=00
PhDs / Projects Guided	Nil
Books Published / IPRs/ Patents	Nil
Professional Memberships	Nil
Consultancy Activities	Nil
Awards	Nil
Grants fetched	Nil
Interaction with Professional Institutions	Nil



Name of Teaching Staff

Designation
 Department
 Date of Joining the Institution
 Qualifications with Class/Grade
 Total Experience in Years Teaching
 No Papers Published in Journals
 Papers Presented in Conferences
 PhD Guide ? Give field & University
 Books Published / IPRs/ Patents
 Professional Memberships
 Consultancy Activities
 Awards
 Grants fetched
 Interaction with Professional Institutions

Gurpreet Singh

Assistant Professor
 Biotechnology
 17-01-2011
 B.Tech (First division)
 0.5yr
 Nil
 Nil
 Nil
 Nil
 Nil
 Nil
 Nil
 Nil
 Nil

**Name of Teaching Staff**

Designation
 Department
 Date of Joining the Institution
 Qualifications with Class/Grade
 Total Experience in Years Teaching
 No Papers Published in Journals
 Papers Presented in Conferences
 PhD Guide ? Give field & University
 Books Published / IPRs/ Patents
 Professional Memberships
 Consultancy Activities
 Awards
 Grants fetched
 Interaction with Professional Institutions

Pallavi Sharma

Assistant Professor
 Biotechnology
 17-01-2011
 B.Tech (First division)
 0.5 years
 Nil
 Nil
 Nil
 Nil
 Nil
 Nil
 Nil
 Nil
 Nil

**Name of Teaching Staff**

Designation
 Department
 Date of Joining the Institution
 Qualifications with Class/Grade
 Total Experience in Years
 No Papers Published in Journals
 Papers Presented in Conferences
 PhD Guide? Give field & University
 PhDs / Projects Guided
 Books Published / IPRs/ Patents
 Professional Memberships
 Consultancy Activities

Arpinder Singh

Associate Professor
 Computer Science & Engineering
 05-08-1995
 M.Sc.(H.S) in Mathematics (Ist)
 M.E. (Computer Sc. & Engg.)
 First with Honors
 24
 National 01 International Nil
 Nil
 Nil
 Nil
 Nil
 Nil
 Nil



Awards
Grants fetched
Interaction with Professional Institutions:

Nil
Rs. 10 lacs From AICTE in MODROB Project
Delivered Expert lectures at GNDU, Asr.

Name of Teaching Staff

Designation
Department
Date of Joining the Institution
Qualifications with Class/Grade

Total Experience in Years
No Papers Published in Journals
Papers Presented in Conferences
PhD Guide? Give field & University
PhDs / Projects Guided
Books Published / IPRs/ Patents
Professional Memberships
Consultancy Activities
Awards
Grants fetched
Interaction with Professional Institutions:

SUNIL KUMAR GUPTA

Associate Professor
Computer Science & Engineering
20/08/1996
B.E. (Computer Sc.) 74.8 %
MS (S/W Systems) CGPA 7.5/10
21 years
National 01 International Nil
Nil
Nil
Nil
Nil
ISTE LM
Nil
Nil
Rs. 8.10 lacs (from AICTE, new Delhi)
Nil



Name of Teaching Staff

Designation
Department
Date of Joining the Institution
Qualifications with Class/Grade

Total Experience in Years
No Papers Published in Journals
Papers Presented in Conferences
PhD Guide? Give field & University
PhDs / Projects Guided
Books Published / IPRs/ Patents
Professional Memberships
Consultancy Activities
Awards
Grants fetched
Interaction with Professional Institutions:

Dr. Rakesh Chandra Gangwar

Associate Professor
Computer Science & Engineering
12th June 1995
B.Tech. (Computer Engg.) 78.12%
M.S. (Software Systems) 80.00%
Ph. D.
19 years
National Nil International 2
Nil
Nil
Nil
Nil
Life member of ACS, IISC, Bangalore
Nil
Nil
Nil
Nil



Name of Teaching Staff

Designation
Department
Date of Joining the Institution
Qualifications with Class/Grade

Sh. Ajay Dogra

Associate Professor
Computer Science & Engineering
17-07-1997
B.Tech Computer Engg. MS(SS)



	1st Class CGPA 8.73
Total Experience in Years	15 Yrs
No Papers Published in Journals	Nil
Papers Presented in Conferences	Nil
PhD Guide? Give field & University	Nil
PhDs / Projects Guided	Nil
Books Published / IPRs/ Patents	Nil
Professional Memberships	Nil
Consultancy Activities	Nil
Awards	Nil
Grants fetched	Nil
Interaction with Professional Institutions:	Nil

Name

Designation

Department

Date of Joining the Institution

Qualifications with Class/Grade

Total Experience in Years Teaching

No Papers Published in Journals

Papers Presented in Conferences

PhD Guide? Give field & University

PhDs / Projects Guided

Books Published / IPRs/ Patents

Professional Memberships

Consultancy Activities

Awards

Grants fetched

Interaction with Professional Institutions:

Guresh Pal Singh

Assistant Professor

Information Technology

9th March, 2005

B.Tech.(First Division)

M.Tech (First Division)

13 years

01 (International Journal)

02 National Conference

Nil

Nil

Nil

Nil

Nil

Nil

Nil

Nil



Name of Teaching Staff

Designation

Department

Date of Joining the Institution

Qualifications with Class/Grade

Total Experience in Years

No Papers Published in Journals National

Papers Presented in Conferences

PhD Guide? Give field & University

PhDs / Projects Guided

Books Published / IPRs/ Patents

Professional Memberships

Consultancy Activities

Awards

Sanjeev Mahajan

Assistant Professor

Computer Science & Engineering

07/08/1997

B. E. (CSE)

Teaching -13 Industry - 05

02

Nil

Nil

Nil

Nil

Nil

Nil

Best Teacher Award for the session 2006-2007 by Principal



Grants fetched Nil
Interaction with Professional Institutions: Nil

Name of Teaching Staff

Designation
Department
Date of Joining the Institution
Qualifications with Class/Grade

Total Experience in Years
No Papers Published in Journals
Papers Presented in Conferences
PhD Guide? Give field & University
PhDs / Projects Guided
Books Published / IPRs/ Patents
Professional Memberships
Consultancy Activities
Awards
Grants fetched
Interaction with Professional Institutions:

Sukhbir Singh

Assistant Professor
Computer Science & Engineering
Sept 2, 1998
B.Tech. (Computer Sc. Engg.)
First Division M.Tech. Pursuing
12 years and 5 months
Nil
Nil
Nil
Nil
Nil
Nil
Nil
Nil
Nil
Nil
Nil



Name of Teaching Staff

Designation
Department
Date of Joining the Institution
Qualifications with Class/Grade
Total Experience in Years Teaching
No Papers Published in Journals
Papers Presented in Conferences
PhD Guide? Give field & University
PhDs / Projects Guided
Books Published / IPRs/ Patents
Professional Memberships
Consultancy Activities
Awards
Grants fetched
Interaction with Professional Institutions:

Sukhwinder Bir

Assistant Professor
Computer Science & Engineering
17/7/2000
UG
10 yaers
Nil
Nil
Nil
Nil
Nil
Nil
Nil
Nil
Nil
Nil
Nil



Name of Teaching Staff

Designation
Department
Engineering
Date of Joining the Institution
Qualifications with Class/Grade
Total Experience in Years
No Papers Published in Journals

Rajeev Bedi

Assistant Professor
Computer Science & Engineering
14/01/2004
M.Tech.(First Division 77%)
10 years
National 04



Papers Presented in Conferences	Nil
PhD Guide? Give field & University	Nil
PhDs / Projects Guided	Nil
Books Published / IPRs/ Patents	Desktop Publishing Tools(for Distance Education Course)
Professional Memberships	Nil
Consultancy Activities	Nil
Awards	Nil
Grants fetched	Nil
Interaction with Professional Institutions:	Nil

Name of Teaching Staff

Designation	Assistant Professor
Department	Computer Science & Engineering
Date of Joining the Institution	14/01/2008
Qualifications with Class/Grade	B-TECH
Total Experience in Years	3.5 years
No Papers Published in Journals	Nil
Papers Presented in Conferences	Nil
PhD Guide? Give field & University	Nil
PhDs / Projects Guided	Nil
Books Published / IPRs/ Patents	Nil
Professional Memberships	Nil
Consultancy Activities	Nil
Awards	Nil
Grants fetched	Nil
Interaction with Professional Institutions:	Nil

Navneet Kaur

Designation	Assistant Professor
Department	Computer Science & Engineering
Date of Joining the Institution	14/01/2008
Qualifications with Class/Grade	B-TECH
Total Experience in Years	3.5 years
No Papers Published in Journals	Nil
Papers Presented in Conferences	Nil
PhD Guide? Give field & University	Nil
PhDs / Projects Guided	Nil
Books Published / IPRs/ Patents	Nil
Professional Memberships	Nil
Consultancy Activities	Nil
Awards	Nil
Grants fetched	Nil
Interaction with Professional Institutions:	Nil



Name of Teaching Staff

Designation	Assistant Professor
Department	Computer Science & Engineering
Date of Joining the Institution	1-AUG-2008
Qualifications with Class/Grade	B-TECH M-TECH (Pursuing)
Total Experience in Years	2.5 years
No Papers Published in Journals	Nil
Papers Presented in Conferences	Nil
PhD Guide? Give field & University	Nil
PhDs / Projects Guided	Nil
Books Published / IPRs/ Patents	Nil
Professional Memberships	Nil
Consultancy Activities	Nil
Awards	Nil
Grants fetched	Nil
Interaction with Professional Institutions:	Nil

Ravneet Kaur

Designation	Assistant Professor
Department	Computer Science & Engineering
Date of Joining the Institution	1-AUG-2008
Qualifications with Class/Grade	B-TECH M-TECH (Pursuing)
Total Experience in Years	2.5 years
No Papers Published in Journals	Nil
Papers Presented in Conferences	Nil
PhD Guide? Give field & University	Nil
PhDs / Projects Guided	Nil
Books Published / IPRs/ Patents	Nil
Professional Memberships	Nil
Consultancy Activities	Nil
Awards	Nil
Grants fetched	Nil
Interaction with Professional Institutions:	Nil



Name of Teaching Staff

Designation
Department
Date of Joining the Institution
Qualifications with Class/Grade
Total Experience in Years
No Papers Published in Journals
Papers Presented in Conferences
PhD Guide? Give field & University
PhDs / Projects Guided
Books Published / IPRs/ Patents
Professional Memberships
Consultancy Activities
Awards
Grants fetched
Interaction with Professional Institutions:

Rakesh Kumar

Assistant Professor
Computer Science & Engineering
17-01- 2011
B.TECH.(First Div.)
1 month
Nil
Nil
Nil
Nil
Nil
Nil
Nil
Nil
Nil
Nil

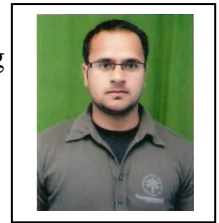
**Name of Teaching Staff**

Designation
Department
Date of Joining the Institution
Qualifications with Class/Grade
Total Experience in Years
No Papers Published in Journals
Papers Presented in Conferences
PhD Guide? Give field & University
PhDs / Projects Guided
Books Published / IPRs/ Patents
Professional Memberships
Consultancy Activities
Awards
Grants fetched
Interaction with Professional Institutions:

Harinder Singh

Assistant Professor
Computer Science & Engineering
17-01- 2011
B. Tech.1st class (72%)
1month
Nil
Nil
Nil
Nil
Nil
Nil
Nil
Nil
Nil
Nil

**Name of Teaching Staff**

Designation
Department
Joining the Institution
Qualifications with Class/Grade
Total Experience in Years
No Papers Published in Journals
Papers Presented in Conferences
PhD Guide? Give field & University
PhDs / Projects Guided
Books Published / IPRs/ Patents
Professional Memberships

Karan Soni

Assistant Professor
Computer Science & Engineering
17-01- 2011
B.TECH. (CSE)
1month
Nil
Nil
Nil
Nil
Nil
Nil



Consultancy Activities Nil
Awards Nil
Grants fetched Nil
Interaction with Professional Institutions: Nil

Name of Teaching Staff

Designation
Department
Date of Joining the Institution
Qualifications with Class/Grade
Total Experience in Years
No Papers Published in Journals
Papers Presented in Conferences
PhD Guide? Give field & University
PhDs / Projects Guided
Books Published / IPRs/ Patents
Professional Memberships
Consultancy Activities
Awards
Grants fetched
Interaction with Professional Institutions:

Gagandeep Singh Hundal

Assistant Professor
Computer Science & Engineering
17-01- 2011
B.TECH.(CSE)
1month
Nil
Nil
Nil
Nil
Nil
Nil
Nil
Nil
Nil
Nil
Nil
Nil



Name of Teaching Staff

Designation
Department
Date of Joining the Institution
Qualifications with Class/Grade
Total Experience in Years
No Papers Published in Journals
Papers Presented in Conferences
PhD Guide? Give field & University
PhDs / Projects Guided
Books Published / IPRs/ Patents
Professional Memberships
Consultancy Activities
Awards
Grants fetched
Interaction with Professional Institutions:

Arshleen Kaur

Assistant Professor
Computer Science & Engineering
17-01- 2011
B.TECH.
1month
Nil
Nil
Nil
Nil
Nil
Nil
Nil
Nil
Nil
Nil
Nil
Nil



Name of Teaching Staff

Designation
Department
Date of Joining the Institution
Qualifications with Class/Grade
Total Experience in Years Teaching

Anil Sagar

Assistant Professor
Information Technology
17-06-2006
B.Tech (First Division)
M.Tech (IT)
7



No Papers Published in Journals	National= 03
Papers Presented in Conferences	Nil
PhD Guide? Give field & University	Nil
PhDs / Projects Guided	Nil
Books Published / IPRs/ Patents	Nil
Professional Memberships	Nil
Consultancy Activities	Nil
Awards	Nil
Grants fetched	Nil
Interaction with Professional Institutions:	Nil

Name of Teaching Staff

Designation	Assistant Professor
Department	Information Technology
Date of Joining the Institution	15 JAN 2009
Qualifications with Class/Grade	BTECH, MTECH (Pursuing)
Total Experience in Years	2 YEAR
No Papers Published in Journals	Nil
Papers Presented in Conferences	Nil
PhD Guide? Give field & University	Nil
PhDs / Projects Guided	Nil
Books Published / IPRs/ Patents	Nil
Professional Memberships	Nil
Consultancy Activities	Nil
Awards	Nil
Grants fetched	Nil
Interaction with Professional Institutions:	Nil

MOHIT MARWAHA

Designation	Assistant Professor
Department	Information Technology
Date of Joining the Institution	15 JAN 2009
Qualifications with Class/Grade	BTECH, MTECH (Pursuing)
Total Experience in Years	2 YEAR
No Papers Published in Journals	Nil
Papers Presented in Conferences	Nil
PhD Guide? Give field & University	Nil
PhDs / Projects Guided	Nil
Books Published / IPRs/ Patents	Nil
Professional Memberships	Nil
Consultancy Activities	Nil
Awards	Nil
Grants fetched	Nil
Interaction with Professional Institutions:	Nil



Name of Teaching Staff

Designation	Assistant Professor
Department	Information Technology
Date of Joining the Institution	20-Jan-2009
Qualifications with Class/Grade	B-Tech M-Tech (Pursuing)
Total Experience in Years	2
No Papers Published in Journals	Nil
Papers Presented in Conferences	Nil
PhD Guide? Give field & University	Nil
PhDs / Projects Guided	Nil
Books Published / IPRs/ Patents	Nil
Professional Memberships	Nil
Consultancy Activities	Nil
Awards	Nil
Grants fetched	Nil
Interaction with Professional Institutions:	Nil

Baljinder Singh

Designation	Assistant Professor
Department	Information Technology
Date of Joining the Institution	20-Jan-2009
Qualifications with Class/Grade	B-Tech M-Tech (Pursuing)
Total Experience in Years	2
No Papers Published in Journals	Nil
Papers Presented in Conferences	Nil
PhD Guide? Give field & University	Nil
PhDs / Projects Guided	Nil
Books Published / IPRs/ Patents	Nil
Professional Memberships	Nil
Consultancy Activities	Nil
Awards	Nil
Grants fetched	Nil
Interaction with Professional Institutions:	Nil



Name of Teaching Staff

Designation
 Department
 Date of Joining the Institution
 Qualifications with Class/Grade
 Total Experience in Years
 No Papers Published in Journals
 Papers Presented in Conferences
 PhD Guide? Give field & University
 PhDs / Projects Guided
 Books Published / IPRs/ Patents
 Professional Memberships
 Consultancy Activities
 Awards
 Grants fetched
 Interaction with Professional Institutions:

Sandeep Kaur

Assistant Professor
 Information Technology
 19-Jan-2009
 B.Tech., M. Tech. (Pursuing)
 3years
 Nil
 Nil
 Nil
 Nil
 Nil
 Nil
 Nil
 Nil
 Nil
 Nil

**Name of Teaching Staff**

Designation
 Department
 Date of Joining the Institution
 Qualifications with Class/Grade
 Total Experience in Years
 No Papers Published in Journals
 Papers Presented in Conferences
 PhD Guide? Give field & University
 PhDs / Projects Guided
 Books Published / IPRs/ Patents
 Professional Memberships
 Consultancy Activities
 Awards
 Grants fetched
 Interaction with Professional Institutions:

RICHA DOGRA

Assistant Professor
 Information Technology
 10 Aug, 2010
 BTECH M-Tech (Pursuing)
 1.5
 Nil
 Nil
 Nil
 Nil
 Nil
 Nil
 Nil
 Nil
 Nil
 Nil

**Name of Teaching Staff**

Designation
 Department
 Date of Joining the Institution
 Qualifications with Class/Grade
 Total Experience in Years
 No Papers Published in Journals
 Papers Presented in Conferences
 PhD Guide? Give field & University
 PhDs / Projects Guided
 Books Published / IPRs/ Patents
 Professional Memberships

Amritpal Singh

Assistant Professor
 Information Technology
 02-08-2010
 B.TECH.
 0.5 year
 Nil
 Nil
 Nil
 Nil
 Nil



Consultancy Activities	Nil
Awards	Nil
Grants fetched	Nil
Interaction with Professional Institutions:	Nil

Name of Teaching Staff

Designation
Department
Date of Joining the Institution
Qualifications with Class/Grade

Rupinder Kaur

Assistant Professor
Information Technology
4 Aug, 2010
B-Tech (IT/First-Div)
M-Tech (CSE Pursuing)



Total Experience in Years
No Papers Published in Journals
Papers Presented in Conferences
PhD Guide? Give field & University
PhDs / Projects Guided
Books Published / IPRs/ Patents
Professional Memberships
Consultancy Activities
Awards
Grants fetched
Interaction with Professional Institutions:

0.5 years
Nil
Nil
Nil
Nil
Nil
Nil
Nil
Nil
Nil
Nil
Nil

Name of Teaching Staff

Designation
Department
Date of Joining the Institution
Qualifications with Class/Grade

Dr. Dial Chand

Professor
Applied Sciences Hum. & Mgt.
29/05/1995.
B.Sc First Division)
M.Sc (First Division) Ph.D



Total Experience in Years Teaching
No Papers Published in Journals
Papers Presented in Conferences
PhD Guide? Give field & University

32
National= 06 International=29
National= 17 International=00
Yes, Magnetic Thermo Elasticity, H.P.
University

PhDs / Projects Guided
Books Published / IPRs/ Patents
Professional Memberships
Consultancy Activities
Awards

05
Nil
ISTAM India & ISTE
Yes

Grants fetched
Interaction with Professional Institutions:

Punjab State Merit Scholarship, Nominated by
ABI(USA) Prestigious award of gold record
Yes in MODROB Projects
H.P. University

Name of Teaching Staff

Designation
Department
Date of Joining the Institution

Dr. Rakesh Dogra

Associate Professor
Applied Sciences Hum. & Mgt.
11/01/2002.



Qualifications	M.Sc.(Physics), P.hD.
Total Experience in Years	Teaching =12 Research = 03
Papers Published	National= 02 International=28
Papers Presented in Conferences	National= Nil International=Nil
PhD Guide. Give field & University	Nil
PhDs / Projects	Nil
Books Published / IPRs/ Patents	Nil
Professional Memberships	Nil
Consultancy Activities	Nil
Awards	Nil
Grants fetched	Nil
Interaction with Professional Institutions	Australian National University, Australia

Name of Teaching Staff

Designation
 Department
 Date of Joining the Institution
 Qualifications with Class/Grade
 Total Experience in Years
 No Papers Published in Journals
 (Attach detail List)
 Papers Presented in Conferences
 (Attach detail List)
 PhD Guide ? Give field & University
 PhDs / Projects Guided
 Books Published / IPRs/ Patents
 Professional Memberships
 Consultancy Activities
 Awards
 Grants fetched
 Interaction with Professional Institutions

SH. JATINDER KUMAR BEHL

Associate Professor
 Applied Sciences Hum. & Mgt.
 06/06/1995.
 M.A.(English)
 Teaching =25
 National= **00** International=**00**
 National= **00** International=**00**



Name of Teaching Staff

Designation
 Department
 Date of Joining the Institution
 Qualifications with Class/Grade
 Total Experience in Years
 No Papers Published in Journals
 Papers Presented in Conferences
 PhD Guide? Give field & University
 PhDs / Projects Guided
 Books Published / IPRs/ Patents
 Professional Memberships
 Consultancy Activities
 Awards

Dr. Sanjay Kumar Srivastava

Associate Professor
 Applied Sciences Hum. & Mgt.
 12/06/1995.
 M.Sc., P.hD
 Teaching =13, Research=03
 National= 0 International=02
 National= 0 International=02
 Nil
 Nil
 Nil
 Nil
 Nil
 Nil



Grants fetched Nil
Interaction with Professional Institutions: Nil

Name of Teaching Staff

Designation
Department
Date of Joining the Institution
Qualifications with Class/Grade
Total Experience in Years
No Papers Published in Journals
Papers Presented in Conferences
PhD Guide ? Give field & University
PhDs / Projects Guided
Books Published / IPRs/ Patents
Professional Memberships
Consultancy Activities
Awards
Grants fetched
Interaction with Professional Institutions

Dr. ARVIND KUMAR
Associate Professor
Applied Sciences, Hum. & Mgt.
04/08/1997.
M.Sc.(Physics). Ph.D.
Teaching =11, Research=03
National= Nil International=14
National= 14 International=Nil
Nil
Nil
Nil
Nil
Nil
Nil
Nil
Nil
Nil



Name of Teaching Staff

Designation
Department
Date of Joining the Institution
Qualifications with Class/Grade
Total Experience in Years
No Papers Published in Journals
(Attach detail List)
Papers Presented in Conferences
(Attach detail List)
PhD Guide ? Give field & University
PhDs / Projects Guided
Books Published / IPRs/ Patents
Professional Memberships
Consultancy Activities
Awards
Grants fetched
Interaction with Professional Institutions

Dr. Rajeev Malhotra
Associate Professor
Applied Sciences Hum. & Mgt.
17/01/2002.
M.Sc Physics, M.Phill, Ph.D
Teaching =12, Research=03
National=03 International=04
National= Nil International=Nil
Nil
Nil
Nil
Nil
Nil
Nil
Nil
Nil
Nil



Name of Teaching Staff

Designation
Department
Date of Joining the Institution
Qualifications with Class/Grade
Total Experience in Years
No Papers Published in Journals

Dr. Anju Awasthi
Associate Professor
Applied Sciences Hum. & Mgt.
30/07/1997.
M.Sc.(Chemistry), Ph.D
Teaching =11, Research=03
Nil



(Attach detail List)
Papers Presented in Conferences Nil
(Attach detail List)
PhD Guide ? Give field & University Nil
Books Published / IPRs/ Patents Nil
Professional Memberships Nil
Consultancy Activities Nil
Awards Nil
Grants fetched Nil
Interaction with Professional Institutions Nil

Name of Teaching Staff

Designation
Department
Date of Joining the Institution
Qualifications with Class/Grade
Total Experience in Years Teaching
No Papers Published in Journals
Papers Presented in Conferences
PhD Guide? Give field & University
PhDs / Projects Guided
Books Published / IPRs/ Patents
Professional Memberships
Consultancy Activities
Awards
Grants fetched
Interaction with Professional Institutions:

HARVINDER KAUR

Assistant Professor
Applied Sciences, Hum. & Mgt
27/07/2004.
M.sc.(maths), M.Ed
08
National= Nil International= Nil
National= Nil International= Nil
Nil
Nil
Nil
Nil
Nil
Nil
Nil
Nil
Nil

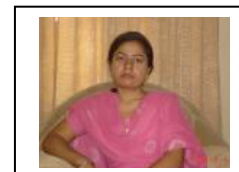

Name of Teaching Staff

Designation
Department
Date of Joining the Institution
Qualifications with Class/Grade
Total Experience in Years
No Papers Published in Journals
Papers Presented in Conferences
PhD Guide ? Give field & University
PhDs / Projects Guided
Books Published / IPRs/ Patents
Professional Memberships
Consultancy Activities
Awards
Grants fetched
Interaction with Professional Institutions

Rishi Tuli

Assistant Professor
Applied Sciences, Hum. & Mgt.
30/10/2008.
M.Sc. (Maths), M.phil
Teaching =05
National= 00 International=00
National= 00 International=00
Nil
Nil
Nil
Nil
Nil
Nil
Nil
Nil
Nil
Nil



Name of Teaching Staff

Designation
 Department
 Date of Joining the Institution
 Qualifications with Class/Grade
 Total Experience in Years
 No Papers Published in Journals
 Papers Presented in Conferences
 PhD Guide ? Give field & University
 Books Published / IPRs/ Patents
 Professional Memberships
 Consultancy Activities
 Awards
 Grants fetched
 Interaction with Professional Institutions

Lovejit Kaur

Assistant Professor
 Applied Sciences, Hum. & Mgt.
 30/10/2008.
 M.Sc. (Chemistry)
 Teaching =2yr
 Nil
 Nil
 Nil
 Nil
 Nil
 Nil
 Nil
 Nil

**Name of Teaching Staff**

Designation
 Department
 Date of Joining the Institution
 Qualifications with Class/Grade
 Total Experience in Years
 No Papers Published in Journals
 Papers Presented in Conferences
 PhD Guide ? Give field & University
 Books Published / IPRs/ Patents
 Professional Memberships
 Consultancy Activities
 Awards
 Grants fetched
 Interaction with Professional Institutions

Vishal Mahajan

Assistant Professor
 Applied Sciences, Hum. & Mgt.
 31/10/2008.
 MBA
 Teaching =03
 Nil
 Nil
 Nil
 Nil
 Nil
 Nil
 Nil
 Nil
 Nil

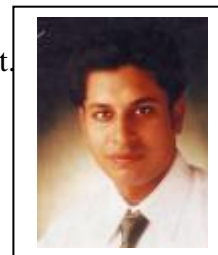
**Name of Teaching Staff**

Designation
 Department
 Date of Joining the Institution
 Qualifications with Class/Grade
 Total Experience in Years
 No Papers Published in Journals
 Papers Presented in Conferences
 PhD Guide ? Give field & University
 Books Published / IPRs/ Patents
 Professional Memberships
 Consultancy Activities
 Awards
 Grants fetched

Mittu Wallia

Assistant Professor
 Applied Sciences, Hum. & Mgt.
 05-08-2009
 M Phil (Mathematics)
 5 years
 Nil
 Nil
 Nil
 Nil
 Nil
 Nil
 Nil



Interaction with Professional Institutions Nil

Name of Teaching Staff

Designation

Department

Date of Joining the Institution

Qualifications with Class/Grade

Total Experience in Years

No Papers Published in Journals

Papers Presented in Conferences

PhD Guide ? Give field & University

Books Published / IPRs/ Patents

Professional Memberships

Consultancy Activities

Awards

Grants fetched

Mrs. Dinesh Sharma

Assistant Professor

Applied Sciences, Hum. & Mgt.

17-01-2011

M Phil (English)

4 years

Nil

Nil

Nil

Nil

Nil

Nil

Nil

Nil



Name of Teaching Staff

Designation

Department

Date of Joining the Institution

Qualifications with Class/Grade

Total Experience in Years

No Papers Published in Journals

Papers Presented in Conferences

PhD Guide ? Give field & University

Books Published / IPRs/ Patents

Professional Memberships

Consultancy Activities

Awards

Grants fetched

Shifali Tuli

Assistant Professor

Applied Sciences, Hum. & Mgt.

17-01-2011

M BA

4 Months

Nil

Nil

Nil

Nil

Nil

Nil

Nil

Nil



Name of Teaching Staff

Designation

Department

Date of Joining the Institution

Qualifications with Class/Grade

Total Experience in Years

No Papers Published in Journals

Papers Presented in Conferences

PhD Guide ? Give field & University

Books Published / IPRs/ Patents

Professional Memberships

Consultancy Activities

Awards

Grants fetched

Nidhi Mahajan

Assistant Professor

Applied Sciences, Hum. & Mgt.

06-01-2010

M. Sc. (Mathematics), B.Ed.

2.5 years

Nil

Nil

Nil

Nil

Nil

Nil

Nil

Nil



Name of Teaching Staff

Designation
 Department
 Date of Joining the Institution
 Qualifications with Class/Grade
 Total Experience in Years
 No Papers Published in Journals
 Papers Presented in Conferences
 PhD Guide ? Give field & University
 Books Published / IPRs/ Patents
 Professional Memberships
 Consultancy Activities
 Awards
 Grants fetched

Navjot Kaur

Assistant Professor
 Applied Sciences, Hum. & Mgt.
 17-01-2011
 M. Sc. , B. Ed. M Phil (Pursuing)
 2.5 years
 Nil
 Nil
 Nil
 Nil
 Nil
 Nil
 Nil
 Nil
 Nil

**Name of Teaching Staff**

Designation
 Department
 Date of Joining the Institution
 Qualifications with Class/Grade
 Total Experience in Years
 No Papers Published in Journals
 Papers Presented in Conferences
 PhD Guide ? Give field & University
 Books Published / IPRs/ Patents
 Professional Memberships
 Consultancy Activities
 Awards
 Grants fetched

Shailly Mahajan

Assistant Professor
 Applied Sciences, Hum. & Mgt.
 19-01-2011
 M. Sc., M Phil (Mathematics)
 4 years
 Nil
 Nil
 Nil
 Nil
 Nil
 Nil
 Nil
 Nil
 Nil

**Name of Teaching Staff**

Designation
 Department
 Date of Joining the Institution
 Qualifications with Class/Grade
 Total Experience in Years
 No Papers Published in Journals
 Papers Presented in Conferences
 PhD Guide ? Give field & University
 Books Published / IPRs/ Patents
 Professional Memberships
 Consultancy Activities
 Awards
 Grants fetched

Mandeep Kaur

Assistant Professor
 Applied Sciences, Hum. & Mgt.
 17-01-2011
 P.G.
 1 month
 Nil
 Nil
 Nil
 Nil
 Nil
 Nil
 Nil
 Nil
 Nil



Name of Teaching Staff

Designation
 Department
 Date of Joining the Institution
 Qualifications

 Total Experience in Years
 Papers Published
 Papers Presented in
 PhD Guide. Give field & University
 PhDs / Projects PhDs
 Books Published / IPRs/ Patents
 Professional Memberships
 Consultancy Activities
 Awards
 Grants fetched

Dr. Nirmal Singh

Professor (on Lien)
 Mechanical Engg.
 08-11-96
 Ph.D, M.Tech,
 B.Tech.
 20
 National = 07 International=06
 Conferences National = 05 International=04
 Dr. J. K. Sharma
 03
 Nil
 AMIE, ISTE
 Yes
 Yes
 Nil

**Name of Teaching Staff**

Designation
 Department
 Date of Joining the Institution
 Qualifications

 Total Experience in Years
 Papers Published
 Papers Presented in
 PhD Guide. Give field & University
 PhDs / Projects PhDs
 Books Published / IPRs/ Patents
 Professional Memberships
 Consultancy Activities
 Awards
 Grants fetched

Dr. O.P. Singh

Professor
 Mechanical Engg.
 22.06.1995
 Ph.D, M.E First Honors,
 B.E. First
 22.5
 National = 07 International=07
 Conferences National = 02 International=01
 02 Ph.D. in Progress
 03 M. Tech Projects
 Contributed chapters in two books
 Iron &Steel Society Japan
 Nil
 Best paper Award by SAIL
 Nil

**Name of Teaching Staff**

Designation
 Department
 Date of Joining the Institution
 Qualifications

 Total Experience in Years
 Papers Published
 Papers Presented in Conferences
 PhD Guide. Give field & University
 PhDs / Projects
 Books Published / IPRs/ Patents
 Professional Memberships

Dr. R.K. Awasthi

Professor
 Mechanical Engg.
 29-11-1996
 Ph.D, B.Tech. (Ist Class),
 M.E. Ist Class
 21
 National = 06 International=Nil
 National = 03 International=Nil
 Nil
 Nil
 Nil
 ISTE, ISME, TSI



Consultancy Activities
Awards
Grants fetched

Material Testing Related
Nil
RPS Project for Rs.12 Laks

Name of Teaching Staff

Designation
Department
Date of Joining the Institution
Qualifications
Total Experience in Years
Papers Published
Papers Presented in Conferences
PhD Guide. Give field & University
PhDs / Projects
PhDs Under Guidance Project at Master level
Books Published / IPRs/ Patents
Professional Memberships
Consultancy Activities
Awards
Grants fetched

Dr. Dilbag Singh

Associate Professor
Mechanical Engg.
12-08-1995
PhD (IITD), B.Tech., M.Tech
20
National = 2 International=4
National = 1 International=6
Nil
M. Tech. Projects-04
03
Nil
ASME, ISTE
Nil
Nil
Nil



Name of Teaching Staff

Designation
Department
Date of Joining the Institution
Qualifications
Total Experience in Years
Papers Published
Papers Presented in Conferences
PhD Guide. Give field & University
PhDs / Projects
PhDs Books Published / IPRs/ Patents
Professional Memberships
Consultancy Activities
Awards IEL,
Grants fetched
Interaction with Professional Institutions

Dr. Jagdev Singh

Associate Professor
Mechanical Engg.
29.08.1997
Ph.D, M.E & B.E (Mech)
23 Years
National (09) International (20)
National (06) International (03)
Nil
02 Guiding, Project at Master level 05
NIL
ISTE & MIE (India)
NIL
Best Paper Award.
NIL
Nil



Name of Teaching Staff

Designation
Department
Date of Joining the Institution
Qualifications
Total Experience in Years
Papers Published
Papers Presented in Conferences

Dr. Ranjit Singh

Associate Professor
Mechanical Engg.
09-11-1995
Ph.D, M.E., B. E.
15
National = 1 International=10
National = 7 International=5



PhD Guide. Give field & University	Nil
PhDs / Projects	01 Ph.D Under progress
Under Guidance Project at Master level	03
Books Published / IPRs/ Patents	Nil
Professional Memberships	SESI, ISTE, PAS
Consultancy Activities	Nil
Awards	Nil
Grants fetched	Nil

Name of Teaching Staff

Designation
 Department
 Date of Joining the Institution
 Qualifications
 Total Experience in Years
 Papers Published
 Papers Presented in Conferences
 PhD Guide. Give field & University field
 PhDs / Projects
 Books Published / IPRs/ Patents
 Professional Memberships
 Consultancy Activities
 Awards
 Grants fetched
 Interaction with Professional Institutions

Sh. Nripjit

Associate Professor
 Mechanical
 05.10.2009
 M. Tech. , B. Tech.
 Teaching-16 Industry- 4.5
 National= 1 International =4
 National= 9 International =4
 Nil
 02
 01
 ISTE Life Member, GENCO International
 Nil
 Nil
 Rs. 59000
 CT Group of Engg. & Tech. Jalandhar



Name of Teaching Staff

Designation
 Department
 Date of Joining the Institution
 Qualifications
 Total Experience in Years
 Papers Published
 Papers Presented in Conferences
 PhD Guide. Give field & University field
 PhDs / Projects
 Books Published / IPRs/ Patents
 Professional Memberships
 Consultancy Activities
 Awards
 Grants fetched
 Interaction with Professional Institutions

Sh. Anil Kumar

Associate Professor
 Mechanical
 16.07.1996
 M.Tech. , B. Tech.
 15
 National= 0 International =8
 National= 0 International =2
 Nil
 05
 Nil
 ISTE Life Member
 Nil
 Nil
 27.5 lakhs RPS
 GGSIP University, Delhi



Name of Teaching Staff

Designation
 Department

Dr. Harish Pungotra

Assistant Professor
 Mechanical Engg.



Date of Joining the Institution	16.07.1996
Qualifications	B. E., M.E., Ph. D.
Total Experience in Years	13 Years
Papers Published	National (0) International (08)
Papers Presented in Conferences	National (01) International (NIL)
PhD Guide. Give field & University	Nil
PhDs / Projects PhDs	Nil
Books Published / IPRs/ Patents	Nil
Professional Memberships	ISTE
Consultancy Activities	Nil
Awards	Nil
Grants fetched	Nil
Interaction with Professional Institutions	University of western Ontario, Canada

Name of Teaching Staff

Designation	Assistant Professor
Department	Mechanical Engg.
Date of Joining the Institution	28.07.1997
Qualifications	M. Tech., B. Tech.
Total Experience in Years	13 Years
Papers Published	National (03) International (08)
Papers Presented in Conferences	National (02) International (02)
PhD Guide. Give field & University	
PhDs / Projects PhDs	Project at Master level (07)
Books Published / IPRs/ Patents	NIL
Professional Memberships	ISTE, TSI, JAENG
Consultancy Activities	NIL
Awards	NIL
Grants fetched	27.5 lakhs RPS
Interaction with Professional Institutions	GGSSIP University, Delhi

Staff* Sh. Naveen Beri

Designation	Assistant Professor
Department	Mechanical Engg.
Date of Joining the Institution	28.07.1997
Qualifications	M. Tech., B. Tech.
Total Experience in Years	13 Years
Papers Published	National (03) International (08)
Papers Presented in Conferences	National (02) International (02)
PhD Guide. Give field & University	
PhDs / Projects PhDs	Project at Master level (07)
Books Published / IPRs/ Patents	NIL
Professional Memberships	ISTE, TSI, JAENG
Consultancy Activities	NIL
Awards	NIL
Grants fetched	27.5 lakhs RPS
Interaction with Professional Institutions	GGSSIP University, Delhi



Name of Teaching Staff

Designation	Assistant Professor
Department	Mechanical Engg.
Date of Joining the Institution	01.08.1997
Qualifications	M.Tech. Ist Class, B. E.
Total Experience in Years	18 Years
Papers Published	National (06) International(05)
Papers Presented in Conferences	National (06) International(04)
PhD Guide. Give field & University	NIL
PhDs / Projects	NIL
Books Published / IPRs/Patents	NIL
Professional Memberships	ISTE, New Delhi PAS, Patiala (PB)
	Tribology Society of India, New Delhi.
	SAE, USA, & India
Consultancy Activities	NIL

Lt. Nirmal Singh

Designation	Assistant Professor
Department	Mechanical Engg.
Date of Joining the Institution	01.08.1997
Qualifications	M.Tech. Ist Class, B. E.
Total Experience in Years	18 Years
Papers Published	National (06) International(05)
Papers Presented in Conferences	National (06) International(04)
PhD Guide. Give field & University	NIL
PhDs / Projects	NIL
Books Published / IPRs/Patents	NIL
Professional Memberships	ISTE, New Delhi PAS, Patiala (PB)
	Tribology Society of India, New Delhi.
	SAE, USA, & India
Consultancy Activities	NIL



Awards

First Rankholder in B.E.
Best Poster in Engg. Section at 6th Sci.
congress at SLIET, Longowal.
Rs. 3.00Laks from AICTE
NIL

Grants fetched

Interaction with Professional Institutions

Name of Teaching Staff

Designation

Department

Date of Joining the Institution

Qualifications

Total Experience in Years

Papers Published

Papers Presented in Conferences

PhD Guide. Give field & University

PhDs / Projects

Books Published / IPRs/ Patents

Professional Memberships

Consultancy Activities

Awards

Grants fetched

Interaction with Professional Institutions

Darshan Kumar

Assistant Professor

Mechanical Engg.

21.09.1998

M.Tech. (Ist div.)

20 Years

National International=07

National= 05 International=2

Nil

02

Nil

ISTE, AMIE, SAE

Nil

Nil

Nil

Nil



Name of Teaching Staff

Designation

Department

Date of Joining the Institution

Qualifications

Total Experience in Years

Papers Published

Papers Presented in Conferences

PhD Guide. Give field & University

PhDs / Projects

Books Published / IPRs/ Patents

Professional Memberships

Consultancy Activities

Awards

Grants fetched

Sh. Sunil Kumar

Assistant Professor

Mechanical

04.09.1998

M.Tech.

13

National = Nil International=Nil

National = 02 International=01

Nil

Nil

Nil

Nil

Nil

Nil

Nil



Name of Teaching Staff

Designation

Department

Date of Joining the Institution

Qualifications

Total Experience in Years

Papers Published

Sh. Brij Bhushan Saini

Assistant Professor

Mechanical

14-09-1998

M. Tech.(First Div.)

22

National = Nil International=04



Papers Presented in Conferences	National = 3 International=02
PhD Guide. Give field & University	Nil
PhDs / Projects	03 at M. Tech. level
Books Published / IPRs/ Patents	Nil
Professional Memberships Member	ISTE
Consultancy Activities	Nil
Awards	Nil
Grants fetched	Nil
Interaction with Professional Institutions	Nil

Name of Teaching Staff

Designation
 Department
 Date of Joining the Institution
 Qualifications
 Total Experience in Years
 Papers Published
 Papers Presented in Conferences
 PhD Guide. Give field & University
 PhDs / Projects
 Books Published / IPRs/ Patents
 Professional Memberships
 Consultancy Activities
 Awards
 Grants fetched

Sarabjit Singh

Assistant Professor
 Mechanical Engg.
 07.08.2001
 M.Tech. (Prod)
 12
 National = 01 International=Nil
 National = 02 International=Nil
 Nil
 Nil
 Nil
 Nil
 Nil
 Nil
 Nil



Name of Teaching Staff

Designation
 Department
 Date of Joining the Institution
 Qualifications
 Total Experience in Years
 Papers Published
 Papers Presented in Conferences
 PhD Guide. Give field & University
 PhDs / Projects

Sanjeev Kumar

Assistant Professor
 Mechanical Engg.
 25.01.2002
 M.Tech.
 12
 National = Nil International=Nil
 National = Nil International=Nil
 Nil
 Nil



Name of Teaching Staff

Designation
 Department
 Date of Joining the Institution
 Qualifications
 Total Experience in Years
 Papers Published
 Papers Presented in Conferences
 PhD Guide. Give field & University

Simranpreet Singh Gill

Assistant Professor
 Mechanical Engg.
 19.05.2005
 M.Tech. / Ist
 6
 National = Nil International=12
 National = 03 International=03
 Nil



PhDs / Projects	Nil
Books Published / IPRs/ Patents	Nil
Professional Memberships	Nil
Consultancy Activities	Nil
Awards	Nil
Grants fetched MODROBS	20 Lakhs

Name of Teaching Staff

Designation
 Department
 Date of Joining the Institution
 Qualifications
 Total Experience in Years
 Papers Published
 Papers Presented in Conferences
 PhD Guide. Give field & University
 PhDs / Projects
 Books Published / IPRs/ Patents
 Professional Memberships
 Consultancy Activities
 Awards
 Grants fetched

Preet Kanwal Singh

Assistant Professor
 Mechanical Engg.
 16-01-2009
 B.Tech
 3.5
 National = Nil International= Nil
 National = Nil International= Nil
 Nil
 Nil
 01 Patent (Square hole drill Machine)
 Nil
 Nil
 Nil
 Nil



Name of Teaching Staff

Designation
 Department
 Date of Joining the Institution
 Qualifications
 Total Experience in Years
 Papers Published
 Papers Presented in Conferences
 PhD Guide. Give field & University
 PhDs / Projects
 Books Published / IPRs/ Patents
 Professional Memberships
 Consultancy Activities
 Awards
 Grants fetched

Jagjit Singh Maan

Assistant Professor
 Mechanical Engg.
 10.08.2009
 B.Tech.
 1.5
 National = 0 International=0
 National = 0 International=0
 Nil
 Nil
 Nil
 Nil
 Nil
 Nil
 Nil



Name of Teaching Staff

Designation
 Department
 Date of Joining the Institution
 Qualifications
 Total Experience in Years
 Papers Published

Arun Nanda

Assistant Professor
 Mechanical Engg.
 17.01.2011
 B.Tech.
 1.5
 National = 0 International=0



Papers Presented in Conferences	National = 0 International=0
PhD Guide. Give field & University	Nil
PhDs / Projects	Nil
Books Published / IPRs/ Patents	Nil
Professional Memberships	Nil
Consultancy Activities	Nil
Awards	Nil
Grants fetched	Nil

Name of Teaching Staff

Designation	Pardeep K Soni
Department	Assistant Professor
Date of Joining the Institution	Mechanical Engg.
Qualifications	17.01.2011
Total Experience in Years	B.Tech.
Papers Published	1month
Papers Presented in Conferences	National = 0 International=0
PhD Guide. Give field & University	National = 0 International=0
PhDs / Projects	Nil
Books Published / IPRs/ Patents	Nil
Professional Memberships	Nil
Consultancy Activities	Nil
Awards	Nil
Grants fetched	Nil

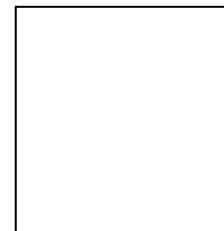

Name of Teaching Staff

Designation	Gurpadam Singh
Department	Associate Professor
Date of Joining the Institution	Electronics & Communication Engg.
Qualifications	17/7/2000
Total Experience in Years	B.E.(1st Class with Honors),
Papers Published in Journals	M.Tech.(1st class)
Papers Presented in Conferences	15 Years
PhD Guide. Give field & University	05
PhDs / Projects Projects:	08
Books Published / IPRs/ Patents	Nil
Professional Memberships	10
Consultancy Activities	Nil
Awards	Nil
Grants fetched	Nil
Interaction with Professional Institutions	Nil



Name of Teaching Staff

Designation	Dr. Amarpal Singh
Department	Associate Professor
	Electronics & Comm. Engg.



Date of Joining the Institution	18-09-1998
Qualifications with Class/Grade	B.Tech(1st class), M.E (1st Class) and PhD
Total Experience in Years	Teaching =17
No Papers Published in Journals	National= 21 International=05
Papers Presented in Conferences	National= 04 International=13
PhD Guide? Give field & University Field:	Nil
PhDs / Projects Guided	PhDs=06 guiding
Books Published / IPRs/ Patents	Nil
Professional Memberships	Member of Institution of Engineers (India)
Consultancy Activities	Nil
Awards	Nil
Grants fetched STTP (AICTE sponsored)	Received grant 90,000/-
Interaction with Professional Institutions:	Nil

Name of Teaching Staff

Designation	Associate Professor
Department	Electronics & Comm. Engg.
Date of Joining the Institution	11/09/1998
Qualifications with Class/Grade	B.Tech. (1st Class) and M.Tech (1st Class)
Total Experience in Years	16 yrs(Teaching)
No Papers Published in Journals	02
Papers Presented in Conferences	02
PhD Guide ? Give field & University	Nil
PhDs / Projects Guided	Nil
Books Published / IPRs/ Patents	Nil
Professional Memberships	Nil
Consultancy Activities	Nil
Awards	Nil
Grants fetched	Nil
Interaction with Professional Institutions	Nil

Parveen Kumar

Designation	Associate Professor
Department	Electronics & Comm. Engg.
Date of Joining the Institution	11/09/1998
Qualifications with Class/Grade	B.Tech. (1st Class) and M.Tech (1st Class)
Total Experience in Years	16 yrs(Teaching)
No Papers Published in Journals	02
Papers Presented in Conferences	02
PhD Guide ? Give field & University	Nil
PhDs / Projects Guided	Nil
Books Published / IPRs/ Patents	Nil
Professional Memberships	Nil
Consultancy Activities	Nil
Awards	Nil
Grants fetched	Nil
Interaction with Professional Institutions	Nil



Name of Teaching Staff

Designation	Associate Professor
Department	Electronics & Comm. Engg.
Date of Joining the Institution	17.07.1996
Qualifications with Class/Grade	B. Tech. and M.Tech.(1st class) PhD (Pursuing)
Total Experience in Years	15 years
No Papers Published in Journals	05(International)
Papers Presented in Conferences	03(International)
PhD Guide ? Give field & University	Nil
PhDs / Projects Guided Projects	06
Books Published / IPRs/ Patents	Nil
Professional Memberships	Nil

Jaswinder Singh

Designation	Associate Professor
Department	Electronics & Comm. Engg.
Date of Joining the Institution	17.07.1996
Qualifications with Class/Grade	B. Tech. and M.Tech.(1st class) PhD (Pursuing)
Total Experience in Years	15 years
No Papers Published in Journals	05(International)
Papers Presented in Conferences	03(International)
PhD Guide ? Give field & University	Nil
PhDs / Projects Guided Projects	06
Books Published / IPRs/ Patents	Nil
Professional Memberships	Nil



Consultancy Activities	Nil
Awards	Nil
Grants fetched	Nil
Interaction with Professional Institutions	Nil

Name of Teaching Staff

Designation
 Department
 Date of Joining the Institution
 Qualifications with Class/Grade
 Total Experience in Years
 No Papers Published in Journals
 Papers Presented in Conferences
 PhD Guide? Give field & University
 PhDs / Projects Guided
 Books Published / IPRs/ Patents
 Professional Memberships
 Consultancy Activities
 Awards
 Grants fetched
 Interaction with Professional Institutions

Ajay Kumar

Associate Professor
 Electronics & Comm. Engg
 18-7-1996
 B.E. (1st Class) and
 M.Tech (1st Class), PhD (perusing)
 15 Years
 National = 03 International = 07
 National = 04
 Nil
 Nil
 Nil
 Life Member of ISTE
 Nil
 Nil
 Nil
 Nil



Name of Teaching Staff

Designation
 Department
 Date of Joining the Institution
 Qualifications with Class/Grade
 Total Experience in Years
 No Papers Published in Journals
 Papers Presented in Conferences
 PhD Guide ? Give field & University
 PhDs / Projects Guided
 Books Published / IPRs/ Patents
 Professional Memberships
 Consultancy Activities
 Awards
 Grants fetched

Neetu

Assistant Professor
 Electronics & Comm. Engg.
 26/07/2007
 B.Tech.(ECE)
 14 Years
 01
 Nil
 Nil
 Nil
 Nil
 Nil
 Nil
 Nil
 Nil



Name of Teaching Staff

Designation
 Department
 Date of Joining the Institution
 Qualifications with Class/Grade
 Total Experience in Years
 No Papers Published in Journals

Mandeep Kaur Sekhon

Assistant Professor
 Electronics & Comm. Engg.
 10/4/2002
 B.E.(1st class) and M.E.(1st Class)
 15 Years
 Nil



Papers Presented in Conferences	Nil
PhD Guide ? Give field & University	Nil
PhDs / Projects Guided	Nil
Books Published / IPRs/ Patents	Nil
Professional Memberships	Nil
Consultancy Activities	Nil
Awards	Nil
Grants fetched	Nil
Interaction with Professional Institutions	Nil

Name of Teaching Staff

Designation	Assistant Professor
Department	Electronics & Comm. Engg.
Date of Joining the Institution	28/07/2004
Qualifications with Class/Grade	B.Tech.(1st Class) and M.Tech. (1st Class)
Total Experience in Years	10 Years
No Papers Published in Journals	02
Papers Presented in Conferences	02
PhD Guide ? Give field & University	Nil
PhDs / Projects Guided	Projects at Masters Level: 05
Books Published / IPRs/ Patents	Nil
Professional Memberships	Nil
Consultancy Activities	Nil
Awards	Nil
Grants fetched	Nil
Interaction with Professional Institutions	Nil

Anita Suman



Name of Teaching Staff

Designation	Assistant Professor
Department	Electronics & Comm. Engg.
Date of Joining the Institution	2-08-2009
Qualifications with Class/Grade	B.Tech.(1st Class), M.Tech(Pursuing)
Total Experience in Years	1.5 year
No Papers Published in Journals	Nil
Papers Presented in Conferences	Nil
PhD Guide ? Give field & University	Nil
PhDs / Projects Guided	Nil
Books Published / IPRs/ Patents	Nil
Professional Memberships	Nil
Consultancy Activities	Nil
Awards	Nil
Grants fetched	Nil
Interaction with Professional Institutions	Nil

Gurpreet Kaur



Name of Teaching Staff

Designation
 Department
 Date of Joining the Institution
 Qualifications with Class/Grade
 Total Experience in Years
 No Papers Published in Journals
 Papers Presented in Conferences
 PhD Guide ? Give field & University
 PhDs / Projects Guided
 Books Published / IPRs/ Patents
 Professional Memberships
 Consultancy Activities
 Awards
 Grants fetched
 Interaction with Professional Institutions

Richa Mahajan

Assistant Professor
 Electronics & Comm. Engg.
 02-08- 2010
 B.Tech. (First)
 0.5 year
 Nil
 Nil
 Nil
 Nil
 Nil
 Nil
 Nil
 Nil
 Nil
 Nil

**Name of Teaching Staff**

Designation
 Department
 Date of Joining the Institution
 Qualifications with Class/Grade
 Total Experience in Years
 No Papers Published in Journals
 Papers Presented in Conferences
 PhD Guide ? Give field & University
 PhDs / Projects Guided
 Books Published / IPRs/ Patents
 Professional Memberships
 Consultancy Activities
 Awards
 Grants fetched
 Interaction with Professional Institutions

Laveena Mahajan

Assistant Professor
 Electronics & Comm. Engg.
 17-01-2011
 B.Tech. (First)
 6 Months
 Nil
 Nil
 Nil
 Nil
 Nil
 Nil
 Nil
 Nil
 Nil
 Nil

**13(b) Polytechnic Teaching Faculty****Name of Teaching Staff**

Designation
 Department
 Date of Joining the Institution
 Qualifications with Class/Grade
 Total Experience in Years
 No Papers Published in Journals
 Papers Presented in Conferences
 PhD Guide? Give field & University
 PhDs / Projects Guided

Mr. Davinder Singh Bhatti

Head of Deptt.
 Computer Science & Engg.
 16-02-2010
 B.Tech (First Division)
 M.Tech. (First Division)
 Teaching = 20
 Nil
 National= 01
 Nil
 Nil



Books Published / IPRs/ Patents Nil
Professional Memberships Nil
Consultancy Activities Nil
Awards Nil
Grants fetched Nil
Interaction with Professional Institutions: -

Name of Teaching Staff

Designation
Department
Date of Joining the Institution
Qualifications with Class/Grade
Total Experience in Years
No Papers Published in Journals
Papers Presented in Conferences
PhD Guide? Give field & University
PhDs / Projects Guided
Books Published / IPRs/ Patents
Professional Memberships
Consultancy Activities
Awards
Grants fetched
Interaction with Professional Institutions:

Mrs. Nirmal Kaur

Lecturer in Mathematics
Applied Science
01-02-2011
M.Sc -Maths (First Division)
Teaching = 5
Nil
Nil
Nil
Nil
Nil
Nil
Nil
Nil
Nil
Nil
-



Name of Teaching Staff

Designation
Department
Date of Joining the Institution
Qualifications with Class/Grade
Total Experience in Years
No Papers Published in Journals
Papers Presented in Conferences
PhD Guide? Give field & University
PhDs / Projects Guided
Books Published / IPRs/ Patents
Professional Memberships
Consultancy Activities
Awards
Grants fetched
Interaction with Professional Institutions:

Ms. Rajni Gupta

Lecturer in English
Applied Science
01-02-2011
M.A, -English (Sec. Division)
Teaching = 3
Nil
Nil
Nil
Nil
Nil
Nil
Nil
Nil
Nil
Nil
-



Name of Teaching Staff

Designation
Department
Date of Joining the Institution
Qualifications with Class/Grade

Ms. Rajbir Kaur

Lecturer in ECE
Electronics & Comm. Engg.
17-01-2011
B.Tech- ECE (First Div.)



Total Experience in Years	Teaching = 1
No Papers Published in Journals	Nil
Papers Presented in Conferences	Nil
PhD Guide? Give field & University	Nil
PhDs / Projects Guided	Nil
Books Published / IPRs/ Patents	Nil
Professional Memberships	Nil
Consultancy Activities	Nil
Awards	Nil
Grants fetched	Nil
Interaction with Professional Institutions:	-

Name of Teaching Staff

Designation
Department
Date of Joining the Institution
Qualifications with Class/Grade
Total Experience in Years
No Papers Published in Journals
Papers Presented in Conferences
PhD Guide? Give field & University
PhDs / Projects Guided
Books Published / IPRs/ Patents
Professional Memberships
Consultancy Activities
Awards
Grants fetched
Interaction with Professional Institutions:

MR. Navjot Singh Bandeshah

Lecturer in Mech. Engg.
Mech. Engg.
17-01-2011
B.Tech- Mech. Engg. (First Div.)
Teaching = 3
Nil
Nil
Nil
Nil
Nil
Nil
Nil
Nil
Nil
-



Name of Teaching Staff

Designation
Department
Date of Joining the Institution
Qualifications with Class/Grade
Total Experience in Years
No Papers Published in Journals
Papers Presented in Conferences
PhD Guide? Give field & University
PhDs / Projects Guided
Books Published / IPRs/ Patents
Professional Memberships
Consultancy Activities
Awards
Grants fetched
Interaction with Professional Institutions:

Ms. Priya Dutt

Lecturer in ECE
Electronics & Comm. Engg.
17-01-2011
B.Tech- ECE (First Div.)
Teaching = 1
Nil
Nil
Nil
Nil
Nil
Nil
Nil
Nil
Nil
-



Name of Teaching Staff

Designation
Department
Date of Joining the Institution
Qualifications with Class/Grade
Total Experience in Years
No Papers Published in Journals
Papers Presented in Conferences
PhD Guide? Give field & University
PhDs / Projects Guided
Books Published / IPRs/ Patents
Professional Memberships
Consultancy Activities
Awards
Grants fetched
Interaction with Professional Institutions:

Ms. Mandeep kaur Minhas

Lecturer in ECE
Electronics & Comm. Engg.
17-01-2011
B.Tech- ECE (First Div.)
Teaching = 3
Nil
Nil
Nil
Nil
Nil
Nil
Nil
Nil
Nil
Nil
-

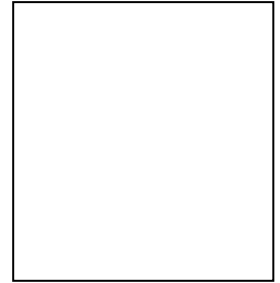
**Name of Teaching Staff**

Designation
Department
Date of Joining the Institution
Qualifications with Class/Grade
Total Experience in Years
No Papers Published in Journals
Papers Presented in Conferences
PhD Guide? Give field & University
PhDs / Projects Guided
Books Published / IPRs/ Patents
Professional Memberships
Consultancy Activities
Awards
Grants fetched
Interaction with Professional Institutions:

MR. Vinod Agnihotri

Lecturer in ECE
Electronics & Comm. Engg.
17-01-2011
B.Tech- ECE (First Div.)
Teaching = 2
Nil
Nil
Nil
Nil
Nil
Nil
Nil
Nil
Nil
Nil
-

**Name of Teaching Staff**

Designation
Department
Date of Joining the Institution
Qualifications with Class/Grade
Total Experience in Years
No Papers Published in Journals
Papers Presented in Conferences
PhD Guide? Give field & University
PhDs / Projects Guided
Books Published / IPRs/ Patents
Professional Memberships

Ms. Gurdeep Kaur

Lecturer in Computer Engg.
Computer Science & Engg.
17-01-2011
B.Tech- CSE (First Div.)
Teaching = 1
Nil
Nil
Nil
Nil
Nil
Nil



Consultancy Activities Nil
Awards Nil
Grants fetched Nil
Interaction with Professional Institutions: -

Name of Teaching Staff

Designation
Department
Date of Joining the Institution
Qualifications with Class/Grade
Total Experience in Years
No Papers Published in Journals
Papers Presented in Conferences
PhD Guide? Give field & University
PhDs / Projects Guided
Books Published / IPRs/ Patents
Professional Memberships
Consultancy Activities
Awards
Grants fetched
Interaction with Professional Institutions:

MR. Rahul Punj
Lecturer in Computer Engg.
Computer Science & Engg.
17-01-2011
B.Tech- CSE (First Div.)
Teaching = 2
Nil
Nil
Nil
Nil
Nil
Nil
Nil
Nil
Nil
Nil
Nil
-



Name of Teaching Staff

Designation
Department
Date of Joining the Institution
Qualifications with Class/Grade
Total Experience in Years
No Papers Published in Journals
Papers Presented in Conferences
PhD Guide? Give field & University
PhDs / Projects Guided
Books Published / IPRs/ Patents
Professional Memberships
Consultancy Activities
Awards
Grants fetched
Interaction with Professional Institutions:

MR. Gagandeep Singh Randhawa
Lecturer in Computer Engg.
Computer Science & Engg.
17-01-2011
B.Tech- CSE (First Div.)
Teaching = 2
Nil
Nil
Nil
Nil
Nil
Nil
Nil
Nil
Nil
Nil
-



Name of Teaching Staff

Designation
Department
Date of Joining the Institution
Qualifications with Class/Grade
Total Experience in Years
No Papers Published in Journals

Mr. Rahul Sharma
Lecturer in Computer Engg.
Computer Science & Engg.
17-01-2011
B.Tech- CSE (First Div.)
Teaching = 1
Nil

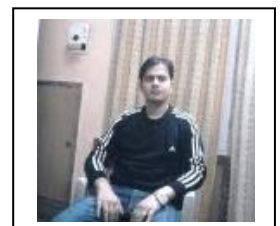

Papers Presented in Conferences	Nil
PhD Guide? Give field & University	Nil
PhDs / Projects Guided	Nil
Books Published / IPRs/ Patents	Nil
Professional Memberships	Nil
Consultancy Activities	Nil
Awards	Nil
Grants fetched	Nil
Interaction with Professional Institutions:	-

Name of Teaching Staff

MR. Sunil Tuli

Designation

Lecturer in Mech. Engg.

Department

Mech. Engg.

Date of Joining the Institution

17-01-2011

Qualifications with Class/Grade

B.Tech- Mech. Engg. (First Div.)

Total Experience in Years

Teaching = 6

No Papers Published in Journals

Nil

Papers Presented in Conferences

Nil

PhD Guide? Give field & University

Nil

PhDs / Projects Guided

Nil

Books Published / IPRs/ Patents

Nil

Professional Memberships

SAE

Consultancy Activities

IMT Batala

Awards

Nil

Grants fetched

Nil

Interaction with Professional Institutions:

-



Name of Teaching Staff

Ms. Amritpal

Designation

Lecturer in Physics

Department

Applied science

Date of Joining the Institution

01-02-2011

Qualifications with Class/Grade

M.Sc-Physics (First Div.)

Total Experience in Years

Teaching = 1.5 years

No Papers Published in Journals

Nil

Papers Presented in Conferences

Nil

PhD Guide? Give field & University

Nil

PhDs / Projects Guided

Nil

Books Published / IPRs/ Patents

Nil

Professional Memberships

Nil

Consultancy Activities

Nil

Awards

Nil

Grants fetched

Nil

Interaction with Professional Institutions:

-



14	Admission quota Entrance test / admission criteria Cut off / last candidate admitted Fees in rupees (Tuition Fee) Number of Fee Waivers offered Admission Calendar PIO quota	85% for Punjab State & 15 % for Other States CET / AIEEE 27590/NA 23242/ 726530 21433/773388 60000 60000 60000 39 24 27 June –Aug 2011 June –Aug 2010 June –Aug 2009 NO
----	--	---

15	Infrastructural information Classroom/Tutorial Room facilities	Yes
----	---	-----

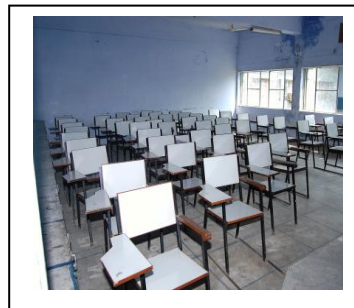
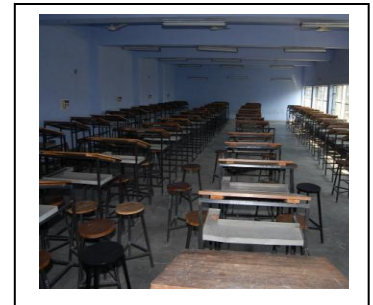

Laboratory details



Computer Centre facilities



Library facilities

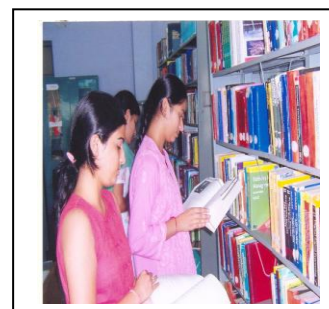
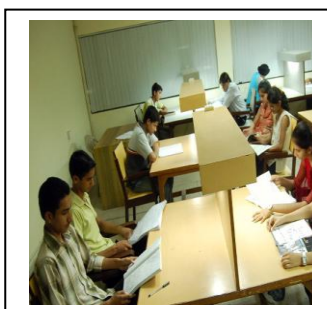

Auditorium / Seminar Halls



Cafeteria

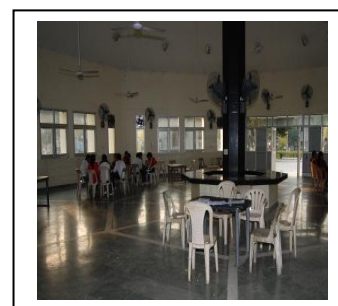

Indoor Sports facilities



Outdoor Sports facilities



Gymnasium facilities



Facilities for disabled /
Any other facilities



Boys Hostel

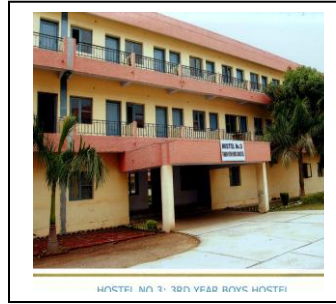

Girls Hostel

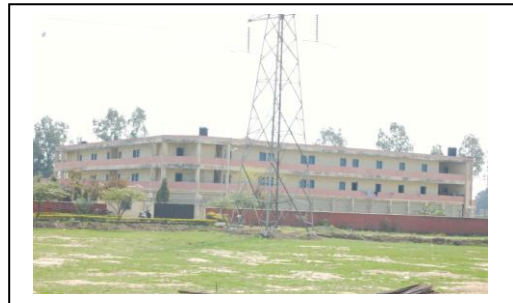

Medical & other Facilities at Hostel



- | | | | |
|-----|--|---|--------------------|
| 17. | Academic Sessions
Examination system
Period of declaration of results | Odd Sem (Aug-Dec) &
Semester
2months | Even Sem (Jan-May) |
| 18. | Counseling / Mentoring

Career Counseling
Medical facilities
Student Insurance | Student Advisors have been nominated at
department Level
Through Training & Placement
Available in College Dispensary
Yes | |
| 19. | Students Activity Body
Cultural activities | Available in College Campus
Fine Arts, Music & Dramatic and Punjab
Sabyacharak Club | |

Sports activities	Table Tennis, Badminton , Basket Ball, Cricket & Lawn Tennis
Literary activities	Literary Society
Magazine / Newsletter	College Magazine twice a year
Technical activities / Tech Fest	ISTE Student Chapter and SAE, Tech-Fest (Annually)
Industrial Visits / Tours	Yes
Alumni activities	Once a Year
20. Name of the Information Officer for RTI	Sh. S. K. Gupta
Designation	Associate Professor (CSE)
Phone number with STD code	01874-221463
FAX number with STD code	01874-221464
Email	skgbcet1965@rediffmail.com